

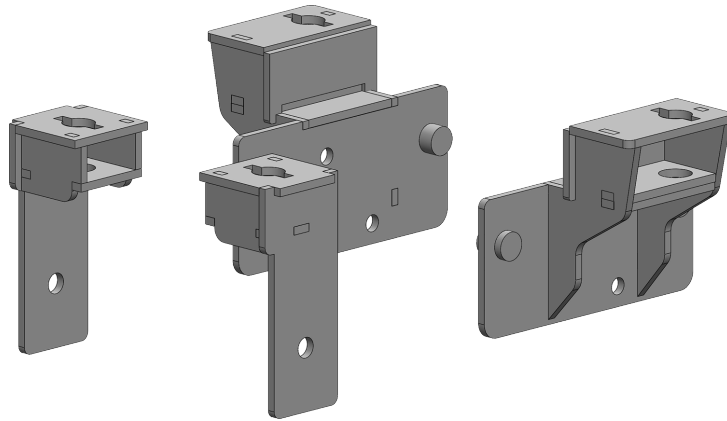

FORD

#3100 SuperRail Mounting Kit

#3123



Gross Trailer Weight (Maximum)..... 12,000 lbs.
Vertical Load Weight (Max. Pin Weight)..... 3,000 lbs.

Installation Instructions

SPECIFICATIONS

- Fits 2015-2020 Ford F-150
- Hitch is located center of the axle
U.S. Pat. No. 6,065,766

TABLE OF CONTENTS

PLATE ASSEMBLY	3
MOUNTING KIT EXPLODED VIEW.....	4
MOUNTING KIT PARTS LIST.....	5
TRUCK PREPARATION.....	6
MARKING THE TRUCK BED FOR DRILLING	6
LAYOUT METHOD.....	6
TEMPLATE METHOD.....	7
INSTALLATION.....	8
PART 1 — BRACKET PLACEMENT & BED HOLE LOCATIONS	8
REAR MOUNTING BRACKET INSTALLATION	8
PART 2 — BRACKET INSTALLATION.....	10
FRONT MOUNTING BRACKET INSTALLATION	10
PART 4 — FINAL INSTALLATION PROCEDURES	10

IMPORTANT

DO NOT OPERATE HITCH UNTIL YOU READ THIS SECTION!

1. The SuperGlide hitch was designed to allow the Turntable Cam Arm Assembly to “glide” along two metal tubes, called the Way Tubes. Since its release in 1998, we have made several advancements in the design, strength, and durability of these components. The Lubrication section of your Owners Manual spans several product releases and design changes. It is *imperative* that you read each section and determine which SuperGlide hitch you purchased, and how to care for it. There have been three major lubrication changes to the SuperGlide hitch:
 - Prior to April 2008, Way Tubes were assembled with either a conventional, quality grade grease or none at all
 - In April 2008, we started coating the Way Tubes with a graphite-based spray lubricant called SlipPlate™
 - November 2009 brings a new innovation from PullRite Towing Systems with the use of plastics. The Turntable Cam Arm Assembly is now equipped with Plastic Wear Plates; see Owners Manual for details (not available for #3600 models)

Depending on when your hitch was manufactured, the Way Tubes of your new SuperGlide hitch will meet one of the above criteria. Each application listed requires some level of maintenance, so it is important that you read the following instructions carefully for the correct lubrication instructions.

Failure to properly lubricate the Way Tubes, as directed in this section, will eventually cause galling between the metals of the Way Tubes and Cam Arm Assembly, which will result in hitch failure. Destruction of various hitch parts is also likely, as well as truck and/or trailer damage, and will not be covered under the Manufacturer’s Warranty.

2. **THE TRAILER’S KING PIN BOX MUST BE EQUIPPED WITH A CAPTURE PLATE (UNIVERSAL OR QUICK CONNECT) TO ALLOW THE HITCH TO FUNCTION (MUST BE PURCHASED SEPARATELY). NOTE: IF YOU HAVE PURCHASED A QUICK CONNECT CAPTURE PLATE AND DID NOT RECEIVE INSTRUCTIONS, THEY ARE AVAILABLE ONLINE, OR YOU CAN CONTACT PULLRITE CUSTOMER SERVICE AT (800) 443-2307.**
3. Failure to modify the length of the brake away cable that activates the emergency braking of your trailer, may cause the cable to catch on protruding parts of the hitch. Resulting damage will not be covered by the manufacturers warranty.
4. There should be a minimum of 6” between the truck bed rails and the under side of the trailer for side tilt clearance. It is the customers responsibility to adjust the trailer king pin box for the appropriate amount of clearance.

NOTE: Some truck models are being manufactured with higher bed sides, making it necessary to adjust the height of your trailer’s king pin box. If you don’t have enough height adjustment available, PullRite produces a 3” Lift Kit that attaches to the rails of your #3100 (ask for part #3108) or #4100, #3300 and #4400 (ask for part #4408; *rated only for 18K when used with model #4400*) SuperGlide models.
5. Some truck beds have contoured bed sides, making the inside bed measurement narrower. Make certain the trailer’s king pin box does not contact the inside edge of the bed.
6. Trucks with bed liners may need a tall Mounting Post. See “NOTE” under “Drilling the Bed” for further details.
7. It is the installers and customers responsibility to ensure there is proper clearance between the truck and trailer. There should be a minimum of 2” of clearance as the trailer passes the cab. Call PullRite technical support with trailer width, make and year of truck and distance the king pin is from leading edge of the trailer (See “Caution” section, in the SuperGlide Owners Manual, for measuring procedure) at (800) 443-2307.
8. Read these instructions completely and follow them accurately. Should you have any questions, please call Customer Service at (800) 443-2307 prior to installation for assistance. *If you did not receive your Owners Manual, visit us online at www.pullrite.com or call the number above.*
9. The SuperGlide was designed for short bed pickup trucks. The hitch may function in a longer bed truck, but no mounting brackets exist to make the transfer. Some #4100 and #4400 mounting kits may transfer with modification.

#3100 SuperGlide Applications

The #3100 SuperGlide was designed for specific short bed pickup trucks. The hitch may function in a longer bed truck, but no mounting brackets exist to easily make the transfer.

PLATE ASSEMBLY

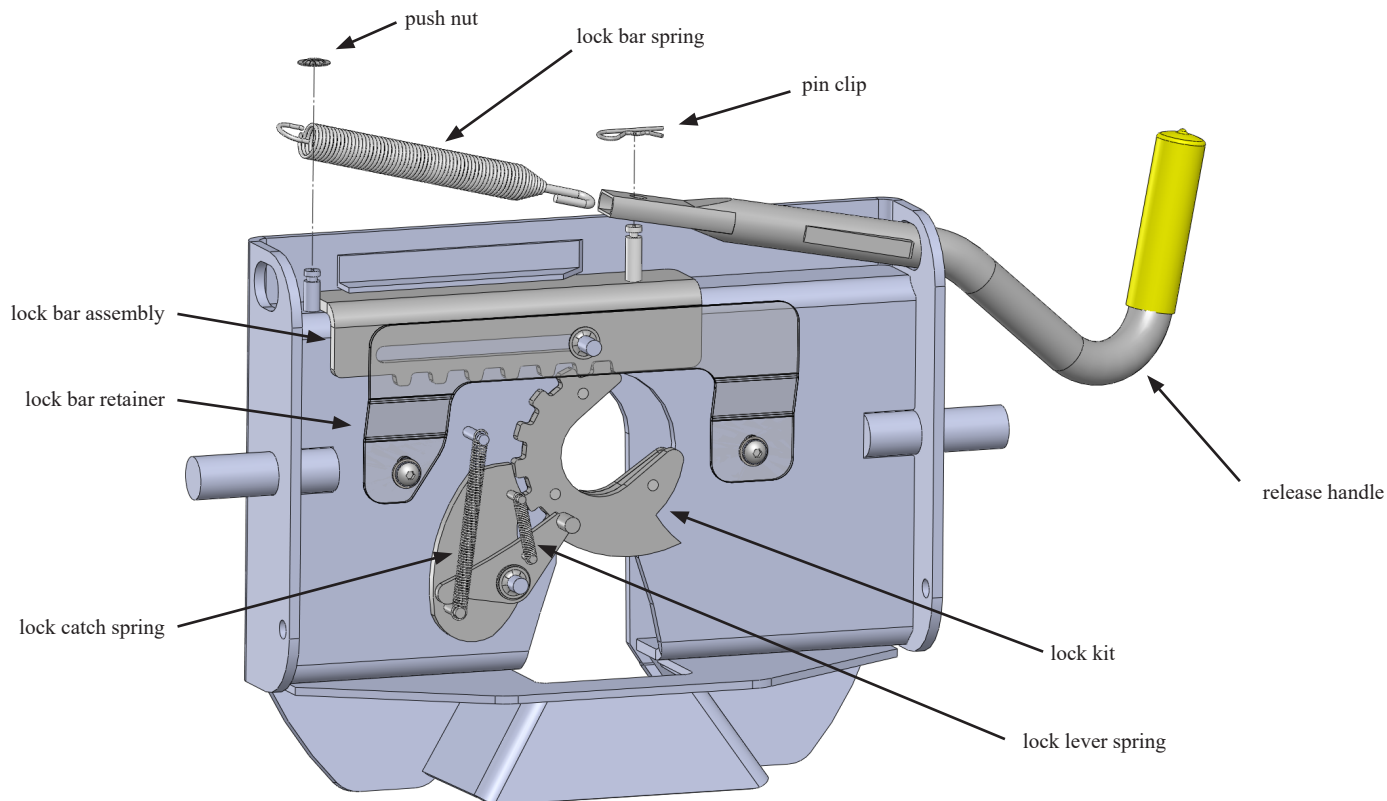

1. Remove the Fifth Wheel Plate from the Rocker Arm and place it upside down on a smooth, clean surface.
2. Insert the Release Handle into the obround hole of the plate as seen above.
3. The Lock Bar Spring must be placed inside the handle prior to placing the handle down over the pin of the Lock Bar Assembly, "catching" the hook inside the handle around the pin.
4. Push the handle and spring assembly down past the groove in the pin of the Lock Bar Assembly, and place the Pin Clip in the groove of the pin to fasten.
5. Grip the body of the spring and stretch it far enough over the opposite pin (welded to the plate) and push it down past the groove.
6. Install the Push Nut to secure the Lock Bar Spring onto the welded pin.

As a PullRite fifth wheel hitch owner, it is important for you to study and manually operate the Fifth Wheel Plate and Release Handle to better understand the locking action. A better working knowledge of the plate will help prevent accidental dropping of your trailer due to incorrect hitching.

Also, it is imperative that you study and adhere to the Maintenance procedures provided in the Owners Manual. If you did not receive one upon purchase, please contact PullRite or visit us on the web at www.pullrite.com.

MOUNTING HARDWARE PARTS IDENTIFICATION

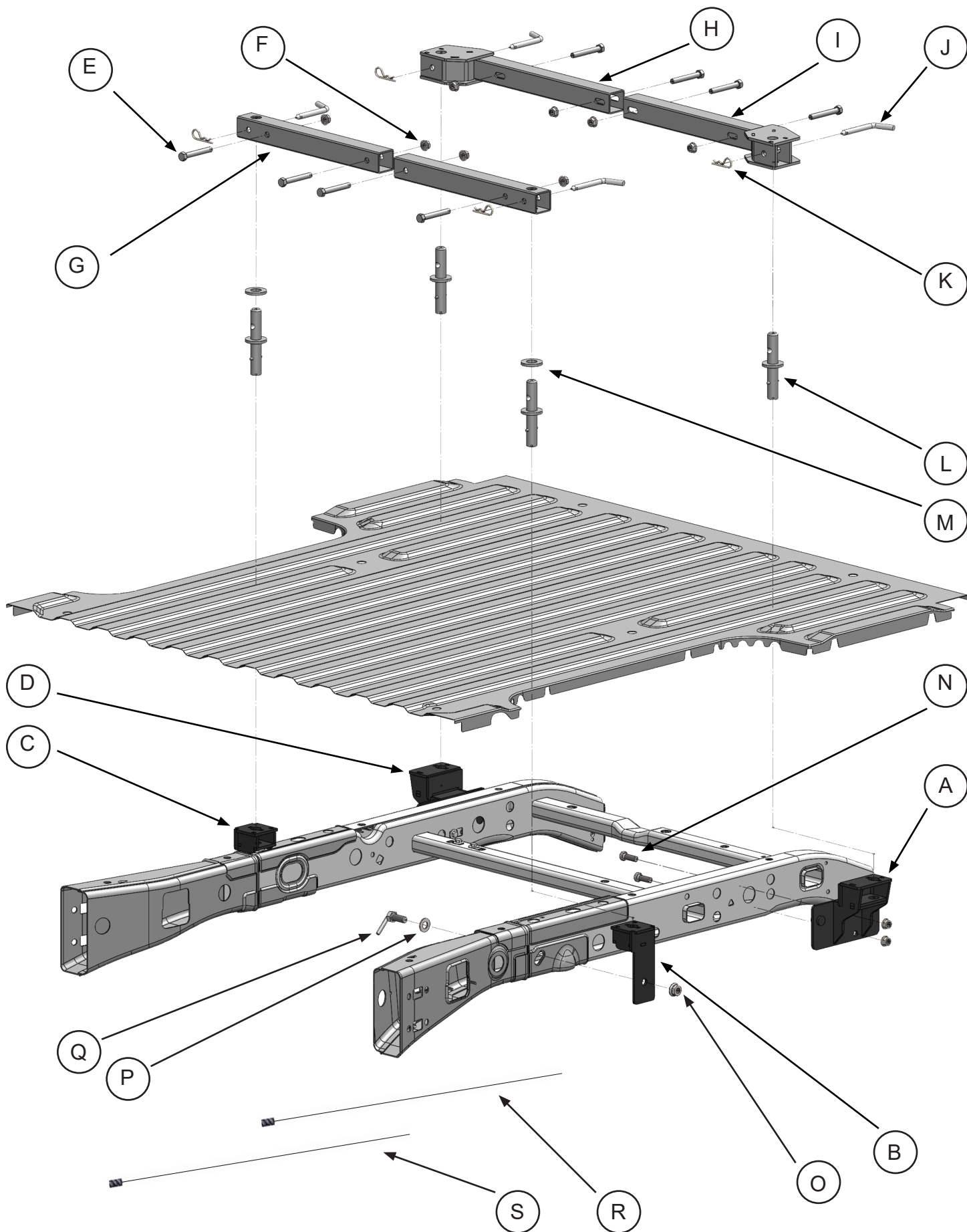

PARTS LIST

#3123 SUPER RAIL MOUNTING KIT

Item	Description	Part No.	Qty.	Material
A	REAR DRIVER SIDE BRACKET	312303	1	
B	FRONT DRIVER SIDE BRACKET	312301	1	
C	FRONT PASSENGER SIDE BRACKET	312302	1	
D	REAR PASSENGER SIDE BRACKET	312304	1	
G	FRONT BASE RAILS	31200601	2	FRONT BASE RAILS (18-7/16" LONG)
H	REAR PASSENGER SIDE BASE RAIL	312309	1	
I	REAR DRIVER SIDE BASE RAIL	312308		

#312305 — MOUNTING BRACKET HARDWARE KIT

Item	Description	Part No.	Qty.	Material
E	BASE RAIL BOLT	98010187	8	1/2"-13 x 3-1/2" HHCS GRD 5
F	1/2" - 13 FLANGE NUT	98150201	12	1/2" - 13 SERRATED FLANGE NUT
J	BASE RAIL PINS	08060001	4	1/2" RD.
K	PIN CLIP	98410143	4	#9 PIN CLIP
L	STANDARD MOUNTING POST	330701	4	3300 MOUNTING POST ASSEMBLY
M	MOUNTING POST FLANGE	33070102	2	
N	SPLINE BOLT	98410192	4	1/2" - 13 x 1-1/2" SPLINE BOLTS
O	FRONT MOUNTING BRACKET FLANGE NUT	98150200	2	5/8"-11 SERRATED FLANGE NUT
P	5/8" FLAT WASHER	98250115	2	5/8" FLAT WASHER
Q	ANTI-ROTATION BOLT	442704	2	5/8" ANTI-ROTATION BOLT
R	1/2" BOLT LEADER	98340197	1	1/2"-13 BOLT LEADER
S	5/8" BOLT LEADER	98340198	1	5/8"-11 BOLT LEADER

LAYOUT TEMPLATE

Description	Part No.	Qty. Used	Material
LAYOUT BED TEMPLATE	31230000	1	ITEM SOLD SEPARATELY

TRUCK PREPARATION

1. Check part quantities using the Parts List.
2. Block vehicle wheels. Some vehicles may require you to raise the rear of the truck in order to make it easier to drill for installing the mounting brackets on the truck frame.
3. You may wish to remove the wheels to give yourself greater working room.
4. If you have purchased a template, proceed to the “Template Method” below; otherwise, begin with the “Layout Method.”

MARKING THE TRUCK BED FOR DRILLING

LAYOUT METHOD

If you purchased an installation template, please proceed “Template Method.” Templates are sold separately.

1. Referencing “Truck Bed Dimension Table” below, measure and mark from the back of the bed forward, the values for “A” and “B”. Do this at any point on both sides of the bed.
2. Draw a line across the bed from mark to mark.
3. Find the centerline of the bed.
4. Draw a line down the middle of the bed from front-to-rear.
5. Center the measurement of “C” across the centerline at the front-most line you made in step 2 and mark the measurement on each side (parallel to the centerline).
6. Center the measurement of “D” for the rear most line made in step 2, and again mark the measurement on each side (parallel to the centerline). This will locate the 4 drill holes.

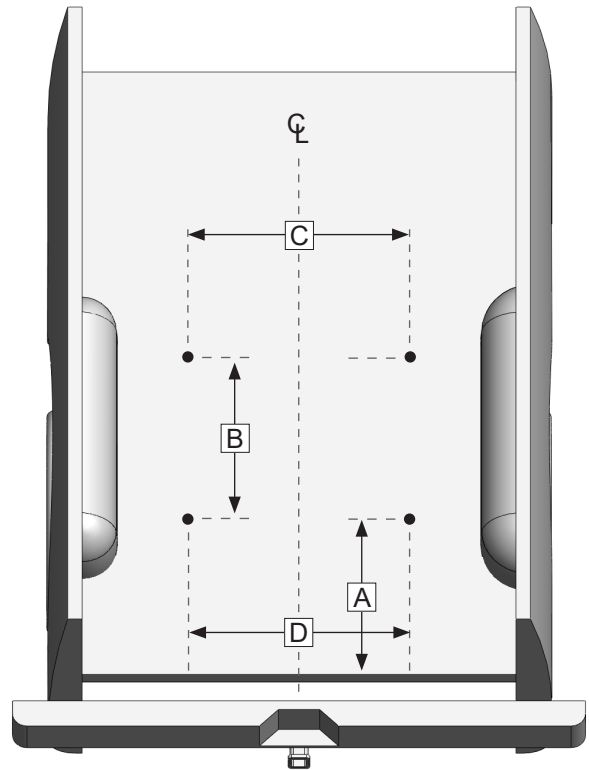

TRUCK BED DIMENSION TABLE					
LAYOUT METHOD				TEMPLATE METHOD	
“A”	“B”	“C”	“D”	“X”	Template part#
17”	27-3/4”	35-15/16”	43-1/4”	16”	31230000

TEMPLATE METHOD

1. Lay the template in the truck bed, centering it from side-to-side, and parallel to the end of the truck bed using the dimension "X" listed in "Truck Bed Dimension Table."
2. Mark the 4 holes as indicated below, making sure the template does not move (see Installation Tip).

INSTALLATION TIP: *The template has a tendency to move when placed on the slick paint of new truck beds, and it may be helpful to place a small piece of NON-SKID matting, such as "SCOOT-GARD"™ or simply use duct tape on each corner to help keep the template from moving.*

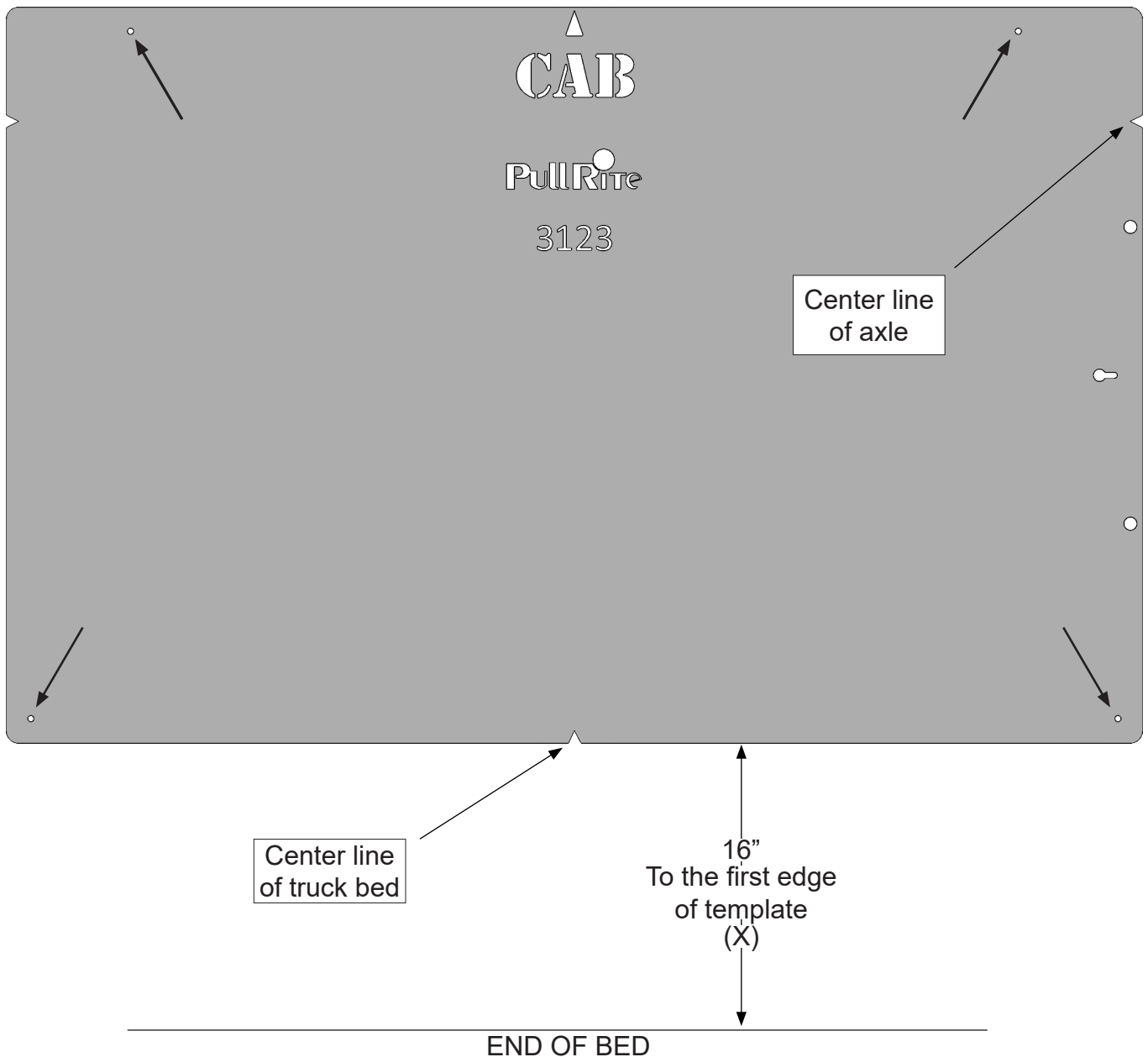

INSTALLATION

Mounting Bracket Installation

Part 1: Bracket Placement & Bed Hole Locations

Since most truck beds are not installed square to the frame or are the same distance from the back of the cab, the installer will need to make sure the bed holes line up properly with the center of each mounting post hole.

The basic steps in this section are as follows:

- *Layout the bed holes*
- *Drill the first pilot hole in the bed*
- *Check centering using the tape method*
- *Adjust the bed hole layout if necessary*
- *Drill the second pilot hole and check centering to ensure bed hole locations are square to the frame; adjust as needed*
- *Drill remaining pilot holes in the bed; check centering*
- *Drill truck frame, if necessary*

Detailed Installation Instructions

1. Use transparent tape to cover the mounting post hole on the top of each mounting bracket (when the pilot hole is drilled through the bed, the tape will be pierced by the small drill; it should be positioned in the center of the 1" mounting post hole).
2. Align the rear driver side mounting bracket {A} by inserting the locator pins on the bracket into the existing holes located on the frame. See illustration below.
3. Fasten the mounting bracket flush to the side of the frame (some mounting brackets may have a slight warp due to the metal characteristics during the welding process) by using a "C" clamp. Do not overtighten.

WARNING: Prior to drilling any holes, be sure to check the inside of the frame to guard against drilling into the fuel tank, wiring, brake lines, fuel module, or other attached items.

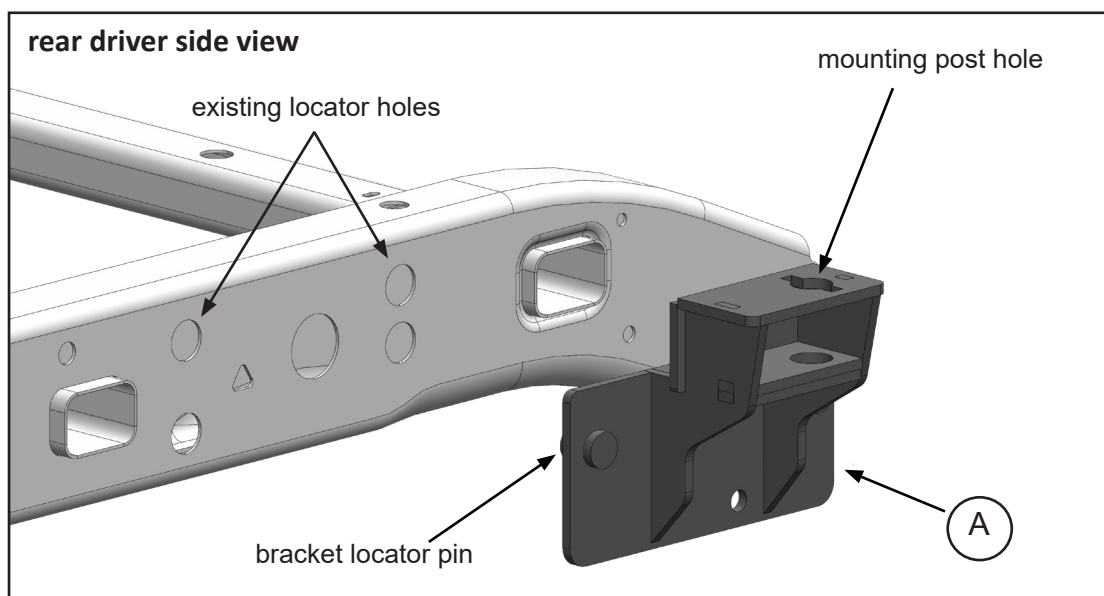

INSTALLATION

4. Drill the first 1/16" pilot hole through the truck bed over the rear hole on the driver side where you made the mark during the "Marking Bed for Drilling." The bit should come down through the 1" mounting post hole, piercing the transparent tape, aiding the centering of the bracket front-to-rear and side-to-side.
5. If the pilot hole is off center to the 1" mounting post hole, remember to adjust all the pilot hole locations accordingly.

NOTE: Some truck beds are not installed square on their frame by the manufacturer. To ensure your pilot holes are aligned properly, it is important that you use the measurements provided only as a starting point and make adjustments as needed. Once you have the rear driver side pilot hole centered, you will use this hole as a point of reference for all remaining pilot hole adjustments. If you are using the Template Method, simply use the properly drilled hole as a pivot point to square the remaining holes to the frame. If you are using the Layout Method, you may accomplish the same thing by using a framing square and straight edge.

6. Repeat Steps 2-5 for the rear passenger side mounting bracket {D}, checking carefully for proper centering.
7. Repeat Steps 3-5 for both front brackets {B} and {C}, making sure both brackets sit flush *on top of the frame*.

NOTE: Final bracket placement is dependent on the fixed position of the rear brackets, due to the pins that are inserted into the frame. The front brackets can be moved forward and back to achieve the 27-3/4", "B" measurement.

WARNING: Before proceeding to "Part 2, "Drilling the Bed..." you must verify that each pilot hole is centered over the 1" mounting post hole on each bracket before the 2" mounting post holes are drilled through the bed

INSTALLATION

Part 2: Drilling the Bed & Bracket Installation

1. Remove the mounting brackets and use a 2" hole saw centered over the 1/16" pilot hole and cut the bed for the mounting posts.
2. De-bur inside the holes and use a paint stick to touch up the edges.

Rear Bracket Installation

1. Reinstall the rear mounting brackets to the frame by inserting the locator pins on the bracket to the existing holes in the frame.
2. Clamp the rear mounting brackets flush to the side of the frame using a "C" clamp.
3. Using the pre-punched holes on the rear mounting brackets as a guide, drill two 1/2" holes through the outside wall of the frame for each bracket.
4. The rear brackets are located on the enclosed portion of the frame and require spline frame bolts for installation.
5. Thread a 1/2" spline bolt {N} onto the 1/2" bolt leader {R} as seen above. Pull through the frame into each of the drilled 1/2" holes, and secure into place by using the supplied flange nut. Repeat for each 1/2" bolt.

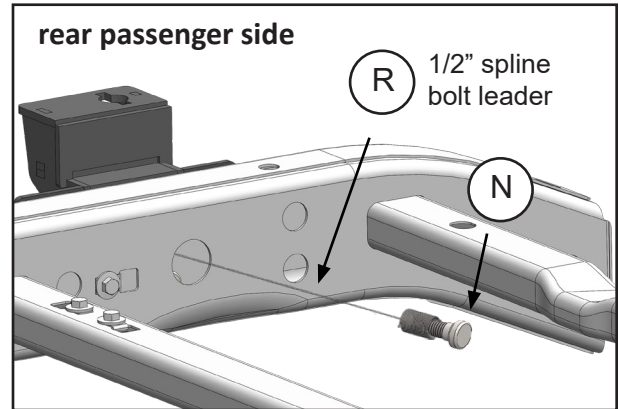

NOTE: Use a hand wrench to tighten the flange nut onto the bolts. Do NOT use an impact wrench, as this can easily strip the spline-to-frame connection.

Front Bracket Installation

1. Reinstall the front mounting brackets to the frame.
2. Secure each bracket in place using a "C" clamp.
3. Thread a 5/8" anti-rotation bolt {Q} onto the 5/8" bolt leader {S} as seen below. Pull through the pre-existing obround hole in the frame, and secure into place by using the supplied 5/8" flange nut {O}. Repeat for remaining front bracket.

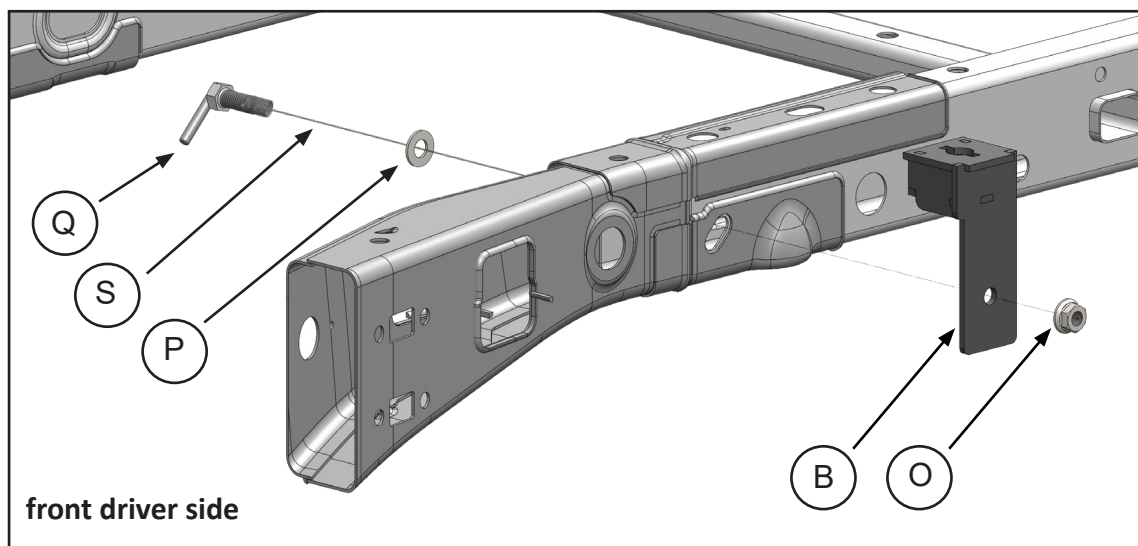

INSTALLATION

3. Install the mounting posts through the bed into the mounting bracket post holders. Rotate the posts a quarter turn (see the illustration to the right). Four posts are required for installation.

NOTE: Vehicles using plastic bed liners may require taller mounting posts (part# 330705) to seat properly into the post holders.

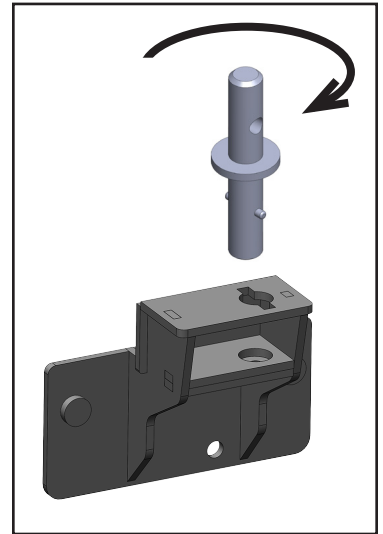

Part 3: Hitch Alignment

1. Remove the SuperGlide hitch from the shipping carton.
2. Install base rails onto the base of the hitch (long base rails at the rear, short rails at the front... obround hole facing downward on all rails), using the supplied bolts (see illustration below).
3. Loosely tighten the base rail bolts to the base allowing lateral movement as you place the rail assembly over the mounting posts.
4. Install the hitch pins and clips to secure the hitch assembly to the base rails. Use a drift pin to aid your hole alignment.
5. Place the hitch on the mounting posts and center on the baserails.

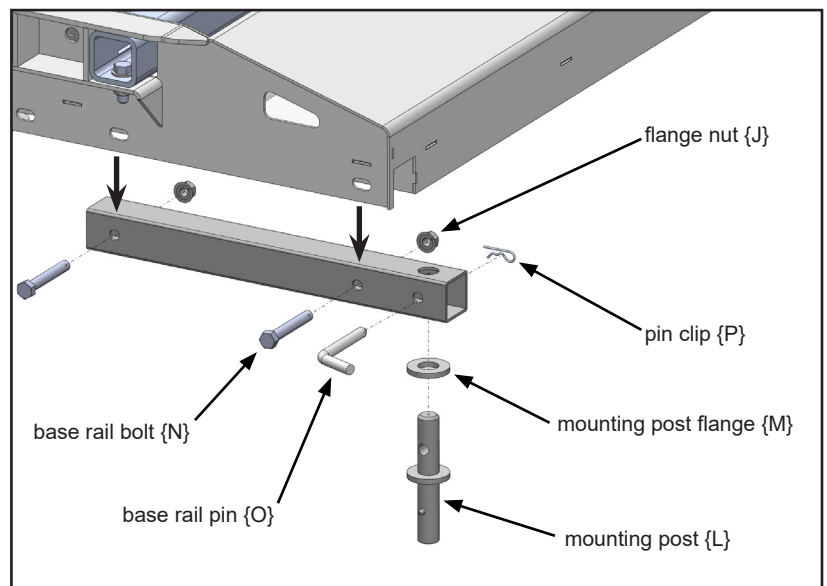

Part 4: Final Installation Procedures

1. Tighten mounting bracket bolts first, then base rail bolts, according to the Torque Table below.
2. Remove the hitch and base rail assembly and verify that the mounting posts can be inserted and turned freely without binding. You may need to loosen the bolts on the mounting brackets below if binding occurs. Adjust as needed and retighten the bolts.
3. Reinstall the mounting posts, the mounting post flanges on each post, base rails, and the SuperGlide hitch, until the assembly can be removed freely without binding.

TORQUE TABLE

3/8" bolt	—	31 ft. lbs.
1/2" bolt	—	75 ft. lbs.
5/8" bolt	—	151 ft. lbs.
3/4" bolt	—	266 ft. lbs.



MANUFACTURED BY:
PULLIAM ENTERPRISES, INC.
13790 East Jefferson Blvd.
Mishawaka, IN 46545
(574) 259-1520 • (800) 443-2307
info@pullrite.com • www.pullrite.com